



NONWOVEN

LINES AND PROCESSES

FOR YEARS TO COME

ANDRITZ

ENGINEERED SUCCESS



Growing your business opportunities

For years to come: We're here to give you support in every aspect of your nonwovens production. You benefit from the most advanced expertise and complete solutions, integrating air-through bonding, needlepunch, spunlace, spunbond, wetlaid/Wetlace, converting, airlay, recycling, and bast fiber processing technologies.

With ANDRITZ, you'll also profit from the highly efficient use of energy and raw materials that rewards you with consistent quality at high capacity for years to come. Experience how our innovative approaches and digital services can give you more control than ever before. All this opens up new opportunities for your product development and your business success.

This is nonwoven eXcellence.

Contents

DRYLAIID, NEEDLEPUNCHED

Geotextile, furniture, technical felts	07
Geotextile, filtration, technical felts	07
Filtration, technical felts	08
Roofing, filtration	08
Technical felts	09
Synthetic leather with special fibers	09
Artificial leather, coating substrates	10
Contract and domestic carpet, rib, carpet backing	10
Automotive	11
Automotive, stitchbonding off-line	11
Automotive, stitchbonding in-line	12
Needled wipes, technical felts	12
Paper felts	13

DRYLAIID, AIRLAY

Bedding, insulation	15
Bedding, automotive, furniture, geotextiles, insulation	15



DRYLAID, DOSING

Hygiene 17

DRYLAID, HYDROENTANGLED

Wipes, medical 19

Hygiene 20

Cotton pads, wipes 20

Technical, coating substrates 21

Wipes, technical 21

DRYLAID, AIR-THROUGH-BONDED

Hygiene 23

DRYLAID, SPECIALTIES

Interlining, hygiene 26

Hygiene 26

Wadding 27

Resinfelt, automotive 28

WETLAID

Wipes, composites 30

Carded-pulp wipes 30

Wipes 31

Glass fibers, carbon 31

Automotive filter, wall coverings 32

Coffee pads, tea bags 32

SPUNLAID

Hygiene, medical 34

Hygiene, medical, technical 34

Roofing, geotextiles 35

Artificial leather, air gas filtration 35

FINISHING OFFLINE

Chemical finishing 37

Hydrofinishing 37

Laminating 38

CONVERTING

Baby diapers, baby pants 40

Sanitary napkins 41

Panty shields 41

Adult diapers, adult pants 42

Light inco 43

Underpads 43

Food pads 44

Laminating 44

Gloves, head rests 45

RECYCLING

Industrial soft waste 47

Industrial waste recycling 47

Pre- and post-consumer waste recycling 48



Drylaid

NEEDLEPUNCHED

A vital part of your business: Mechanical bonding defines the quality of your fabric. That's why needlepunch lines from ANDRITZ give your business the extra punch. They increase your uptime due to their reliable design, low maintenance requirements and easy cleaning processes.

Needlepunching gives you high flexibility and suitability for use with nearly all existing fibers, from natural to man-made fibers, and filaments. You can also customize the fabric's tensile strength and weight distribution. It serves demanding markets such as automotive, geotextiles, building and civil engineering, filtration, and synthetic leather.



Geotextile, furniture, technical felts

75 – 700 gsm

- Roofing
- Home furnishings
- Geotextile
- Automotive
- Carpet backing

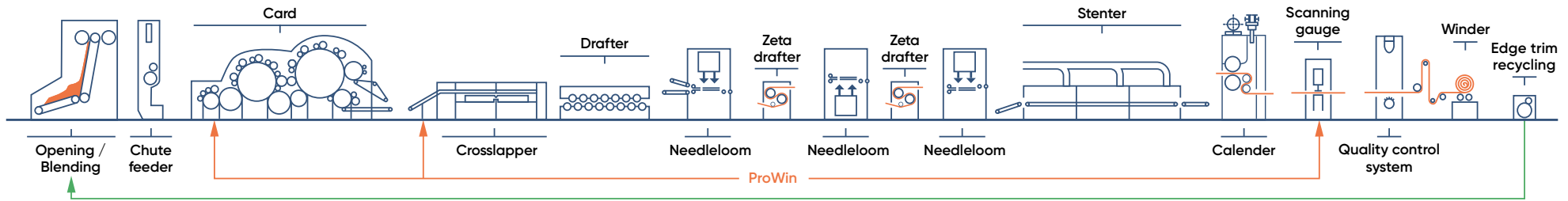

Geotextile, filtration, technical felts

90 – 1,000 gsm

- Technical filters
- Cable wraps
- Needlepunched wipes
- Densified technical felts
- Automotive felts

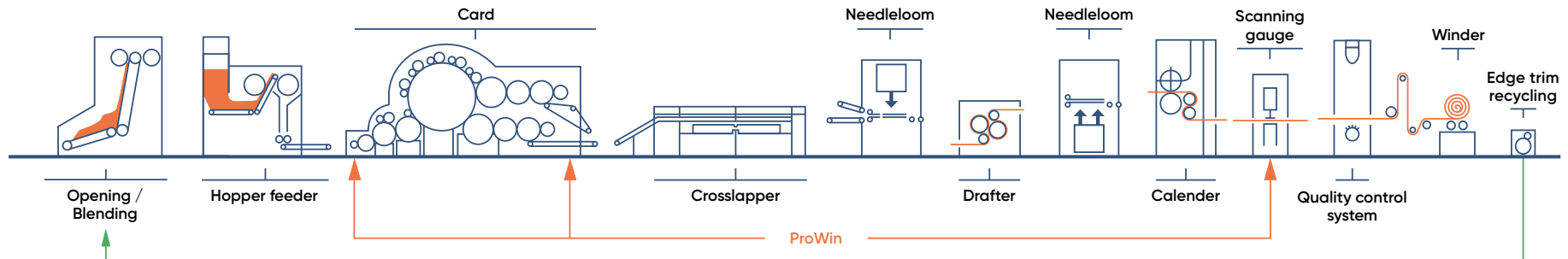



Filtration, technical felts

90 – 1,600 gsm

- Technical filters
- Needlepunched wipes
- High-density technical felts
- Automotive felts

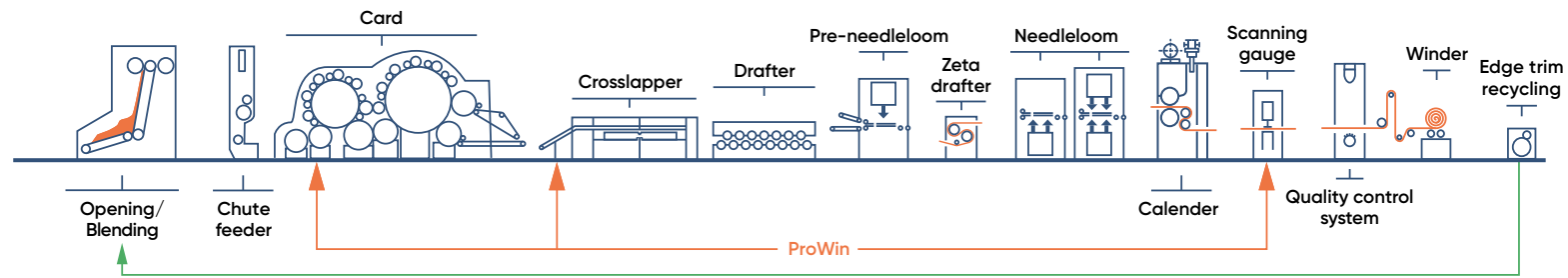

Roofing, filtration

120 – 350 gsm

- Roofing
- Filtration
- Technical felts

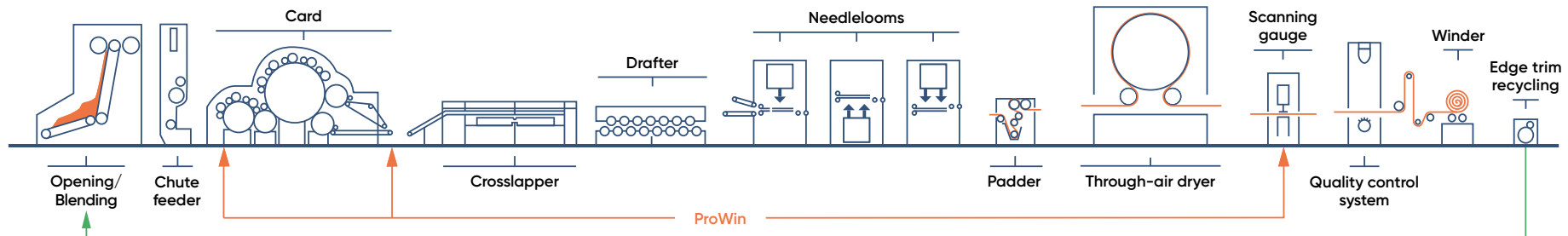



Technical felts
120 – 2,000 gsm

- Technical felts
- Geotextile

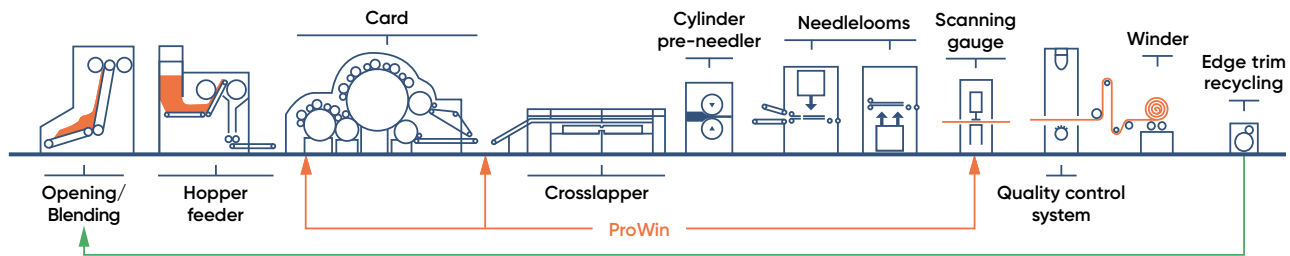

Synthetic leather with special fibers
200 – 800 gsm

- Synthetic leather made from microdenier or "Sea and Island" fibers

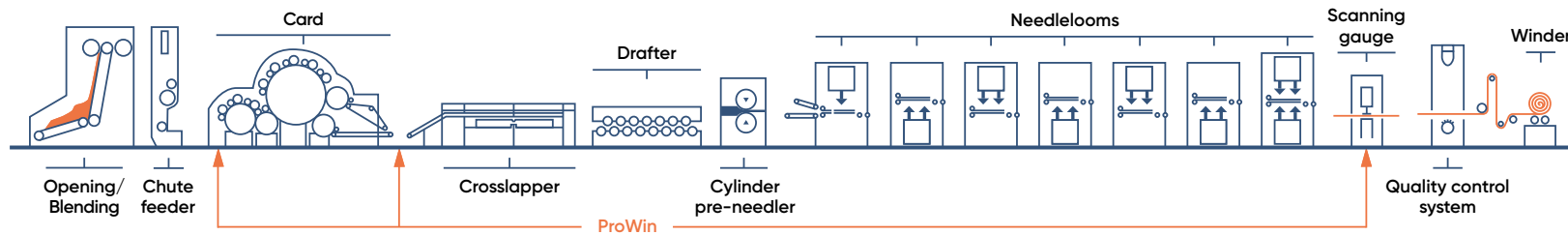



Artificial leather, coating substrates

80 – 400 gsm

- Artificial leather
- Coating substrates
- Technical felts

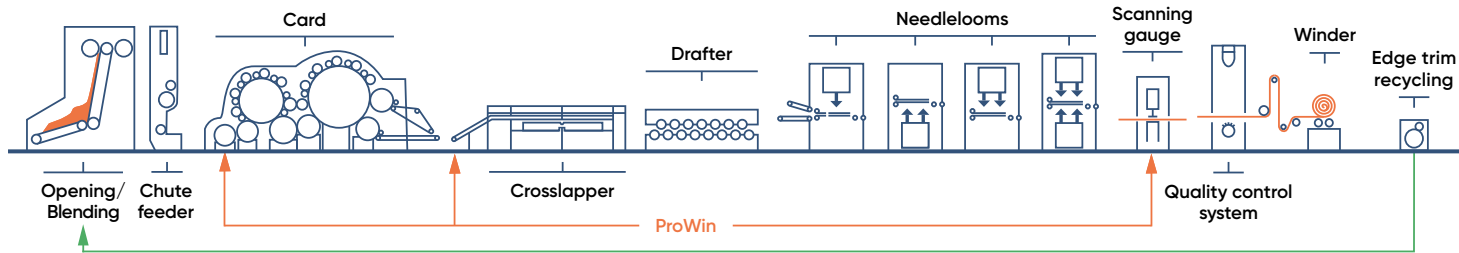

Contract and domestic carpet, rib, carpet backing

120 – 2,000 gsm

- Wall coverings
- Floor coverings
- Carpet backing

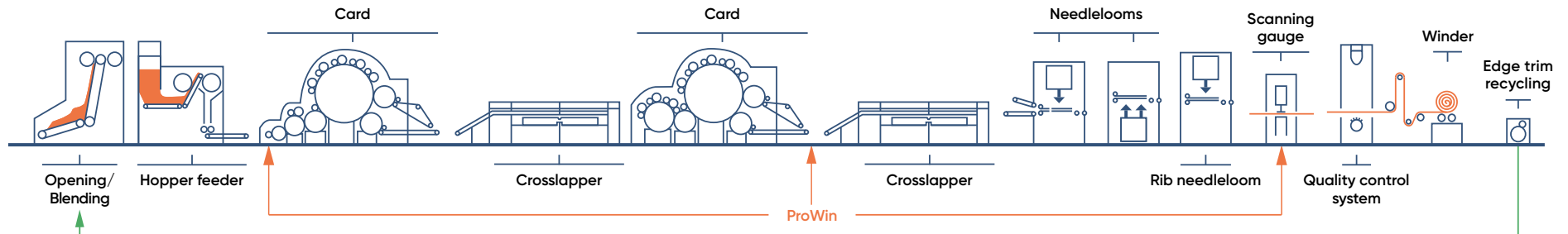



Automotive
150 – 600 gsm

- Headliners
- Automotive felts

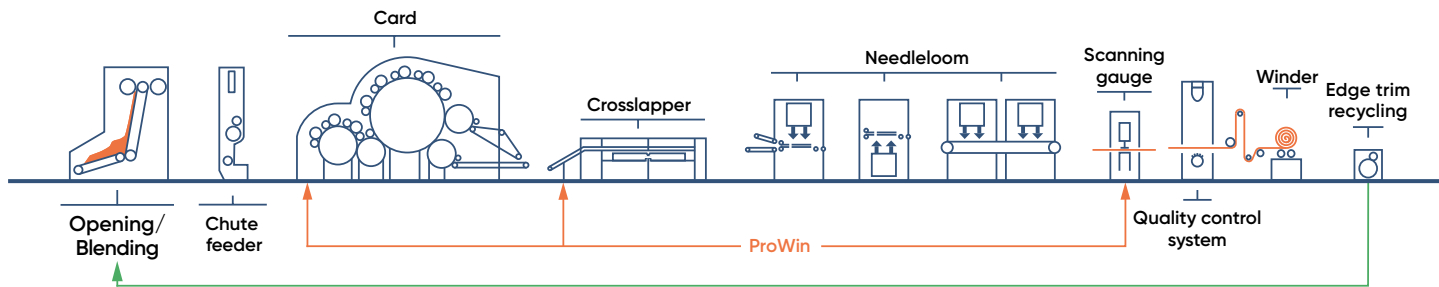

Automotive, stitchbonding off-line
100 – 200 gsm

- Automotive headliners
- Vertical blinds
- Filters
- Mattress manufacturing

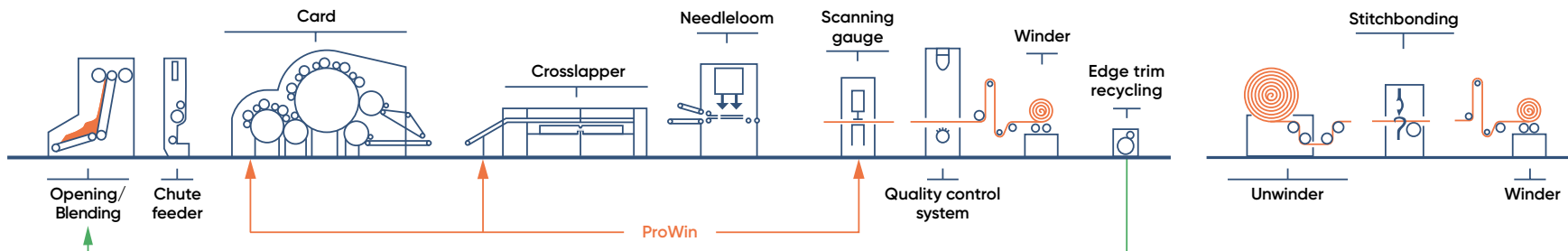



Automotive, stitchbonding in-line

120 – 200 gsm

- Automotive headliners

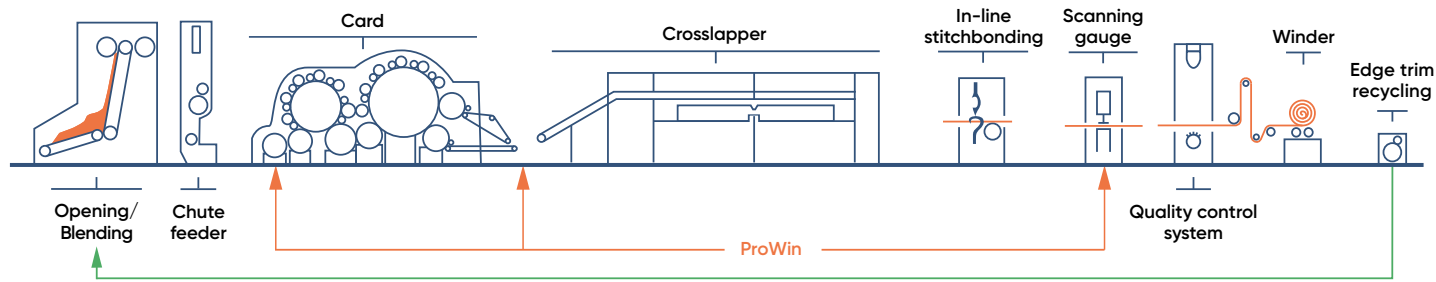

Needled wipes, technical felts

80 – 200 gsm

- Wipes, cleaning cloths
- Technical felts
- Technical filters
- Automotive felts

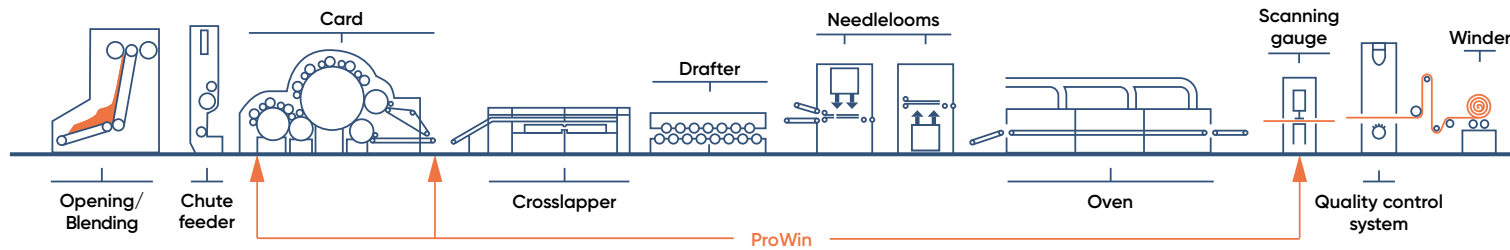



Paper felts

100 – 160 gsm

- Paper felts up to 16 m width

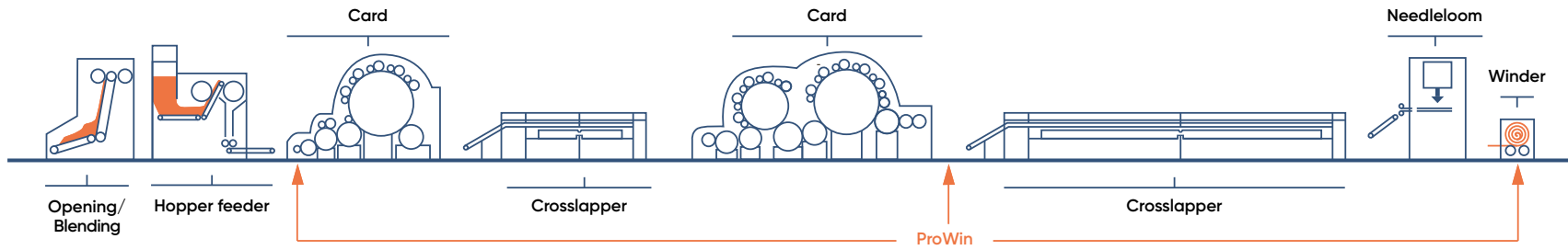

Drylaid

AIRLAY

Drive your business with airlay: ANDRITZ provides high expertise with the airlay process for nonwovens. The ANDRITZ airlay technology can process all types of fibers and solid particles. It is offered as a complete line with needlepunch, thermobonding or other bonding methods for numerous applications in the furniture, automotive, bedding, insulation, or filtration industries.



Bedding, insulation

300–10,000 gsm

- Bedding felt
- Home furniture
- Building insulation
- Technical nonwovens

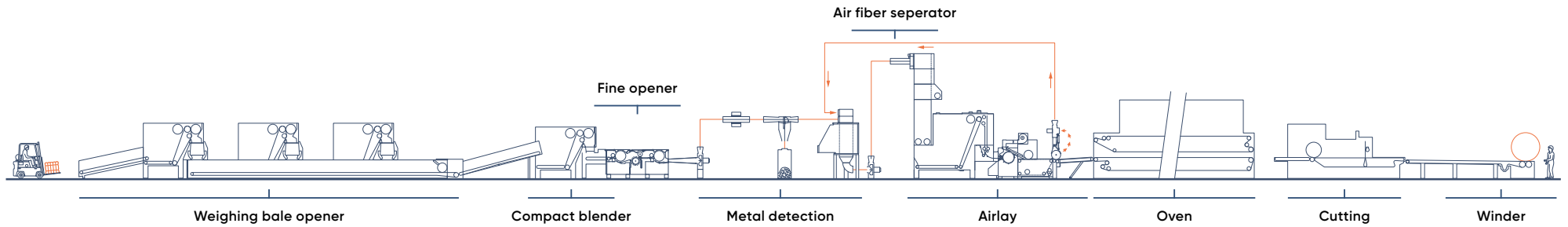

Bedding, automotive, furniture, geotextiles, insulation

300–5,000 gsm

- Automotive insulation felt
- Carpet underfelt
- Building insulation
- Geotextile

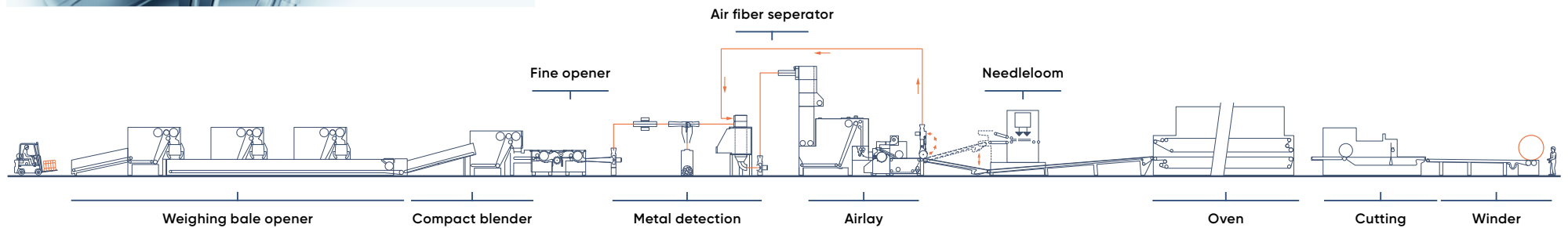

Drylaid

DOSING

Dosing technology for a first-class product: The ANDRITZ dosing process is designed to open fiber bales and to accurately meter a flow of fibers into a downstream process e.g. airlaid paper, diaper machines, and much more. The high accuracy of such lines is guaranteed with the state-of-the-art density control system.



Hygiene
40 – 1,000 kg/h

- Airlaid paper
- Diaper machines
- Paper industry

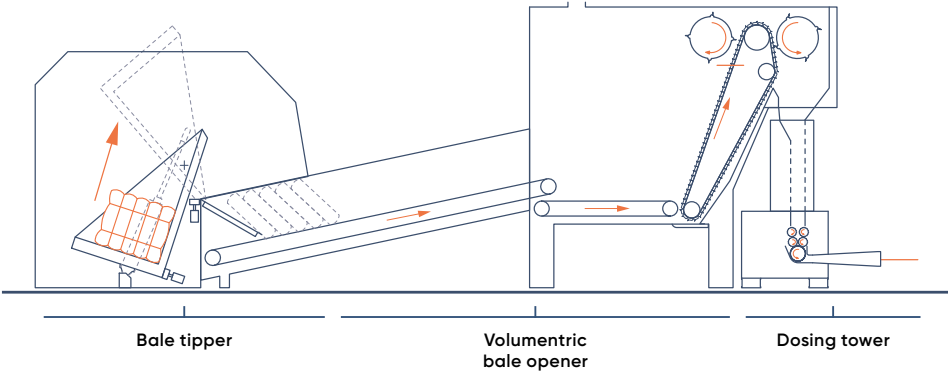
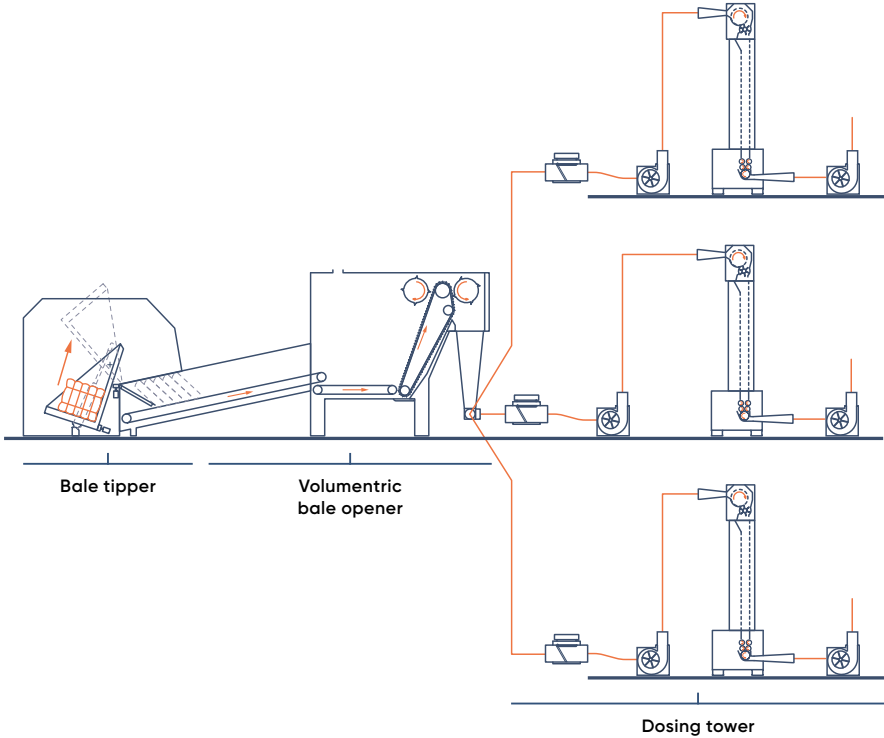

Drylaid

HYDROENTANGLED

Discover the most efficient hydroentanglement: If you strive for success in spunlace nonwoven roll goods, efficiency and flexibility are key. neXline spunlace lines from ANDRITZ offer you solutions to save time and money.

Spunlace fabrics are made from all types of raw materials – natural or synthetic. Softness, drape, comfort, conformability, high strength, and the fact that they contain no chemicals are the major characteristics that make spunlace nonwovens unique.

Spunlace can be used for a large number of markets, such as baby care, cosmetics, household wipes, technical and hard-surface wipes, face masks, diaper ears, top sheet and back sheet, cotton pads, medical and surgical, coating substrates, automotive, filtration, wallpaper, and many more.



Wipes, medical

30 – 100 gsm

- Wet wipes
- Dry wipes
- Medical gauze
- Wall paper

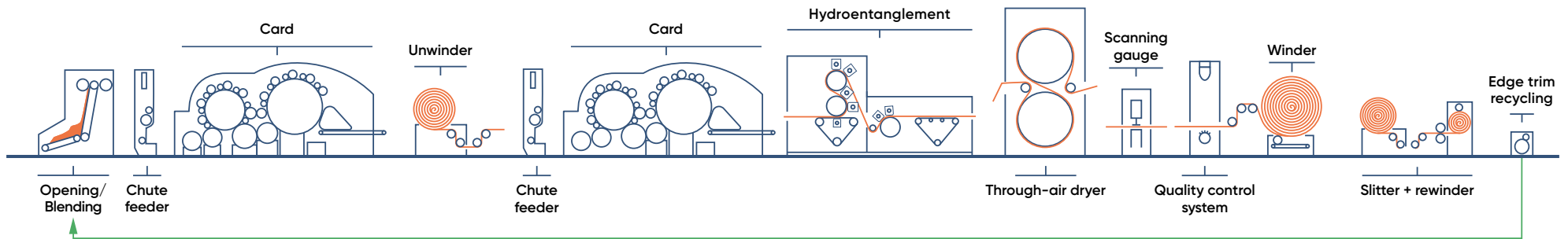

Wipes, medical

30 – 100 gsm

- Face mask
- Wipes, cleaning cloths

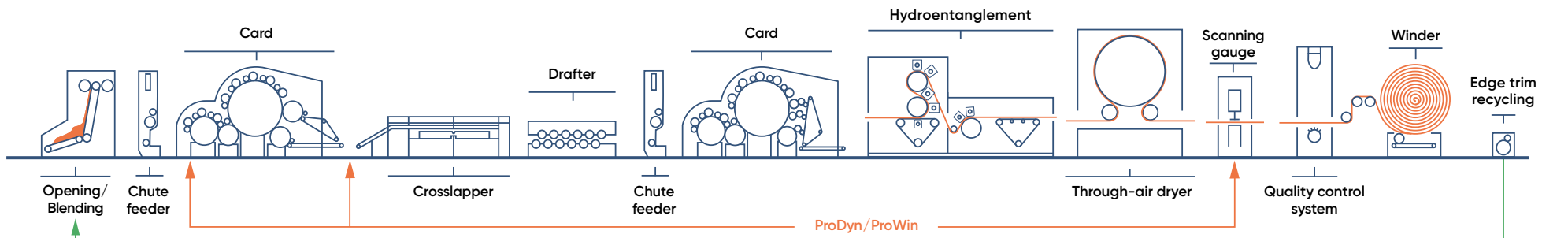



Hygiene

20 – 80 gsm

- Top sheet
- Back sheet

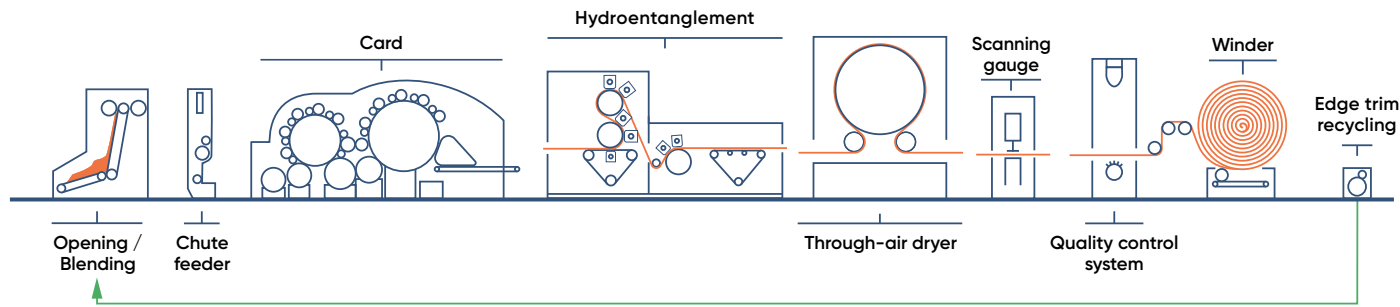

Cotton pads, wipes

30 – 270 gsm

- Cosmetics
- Hygiene

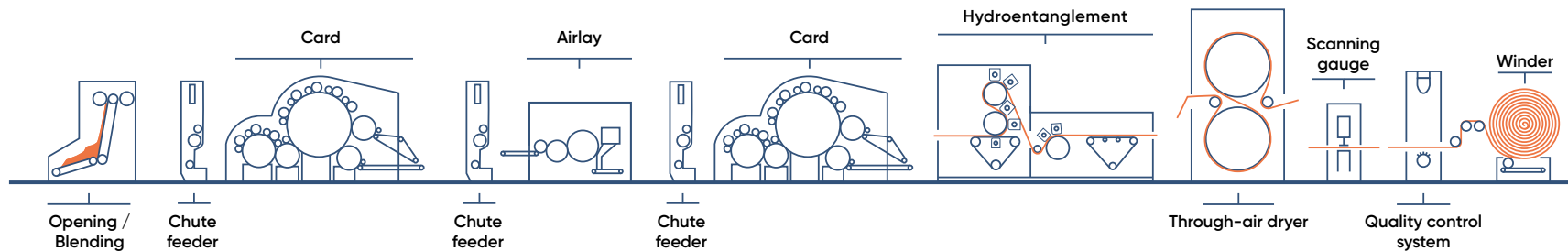



Technical, coating substrates

50 – 400 gsm

- Coating substrates
- Health care
- Home furnishings
- Automotive
- Electronics industry

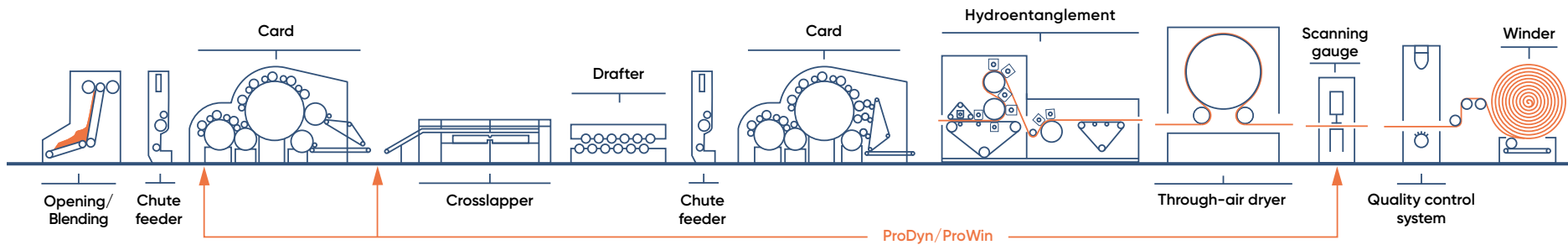

Wipes, technical

50 – 150 gsm

- Health care
- Wipes, cleaning cloths
- Coating substrates
- Technical filters

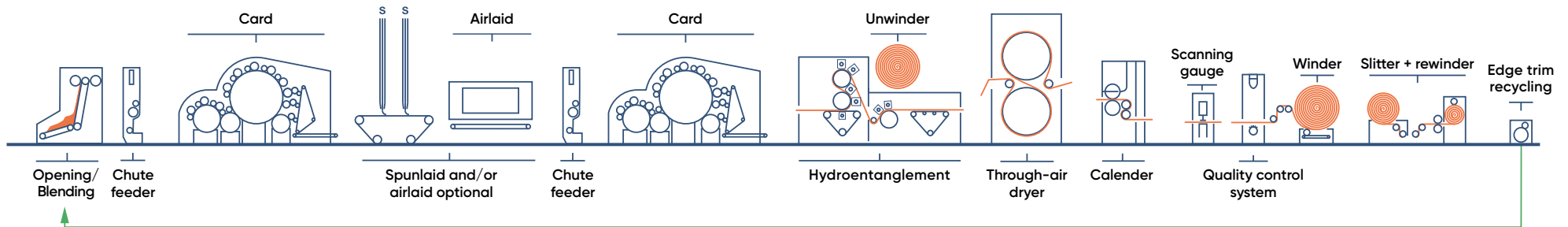

Drylaid

AIR-THROUGH-BONDED

In daily life, products using air-through-bonding technology are everywhere.

The hygiene market requires products with high uniformity, softness, bulkiness, and tensile strength. Due to population growth, aging of the population, rise in of the standard of living, and so on, these products provide the perfect response to the requested quality level for baby diapers, feminine hygiene or adult incontinence products.

Air-through-bonding lines deliver all nonwovens fabric characteristics for hygiene end uses, such as top sheets, acquisition distribution-layers, and back sheets. The well-known ANDRITZ carding machines are the key to success in achieving perfect web uniformity and comfort.



Hygiene

16 – 80 gsm

- Top sheet
- Back sheet
- Acquisition distribution layer

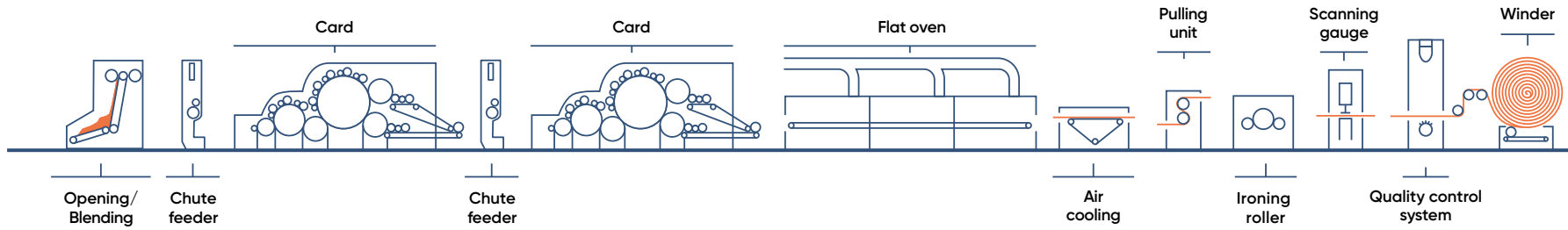

Hygiene

16 – 80 gsm

- Top sheet
- Back sheet
- Acquisition distribution layer

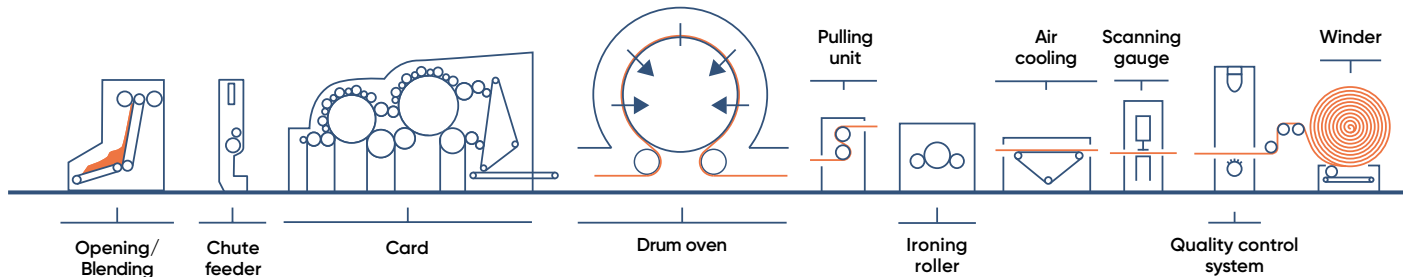



Hygiene

16 – 80 gsm

- Top sheet
- Back sheet
- Acquisition distribution layer

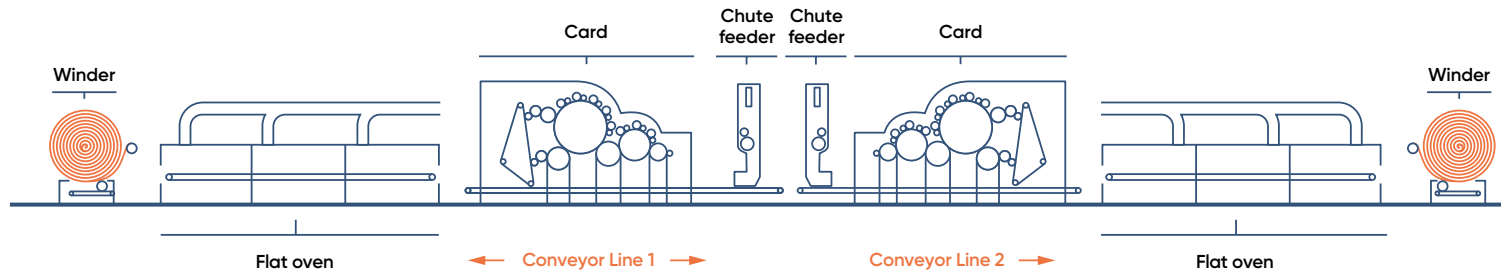

Drylaid

SPECIALTIES

Special markets need special machines: For durable and disposable end uses we offer customized machines and lines to suit your needs perfectly.

Applications for hygiene, interlining or wadding can be produced smoothly with our technologies.



Interlining, hygiene

15 – 50 gsm

- Interlining
- Coverstock

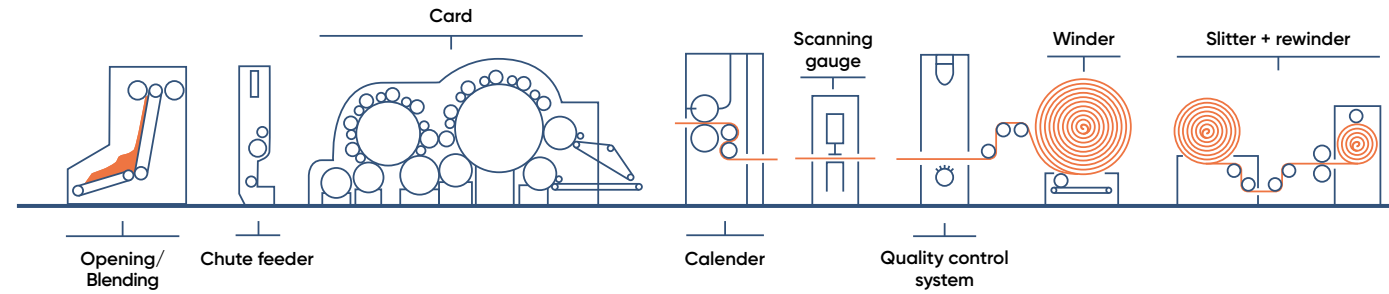

Hygiene

20 – 100 gsm

- Health care
- Coverstock for baby diapers, adult incontinence, and femcare
- Acquisition distribution layer

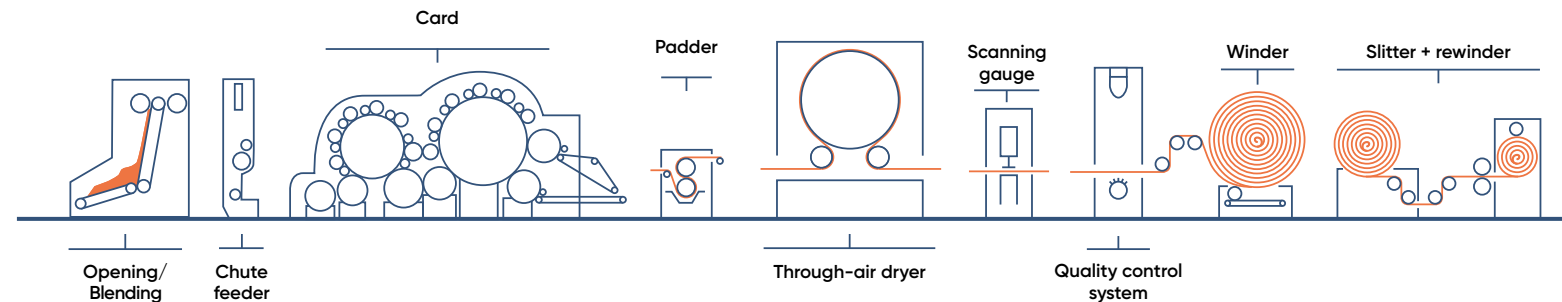



Hygiene

20 – 100 gsm

- Acquisition distribution layer
- Top sheet for baby diapers

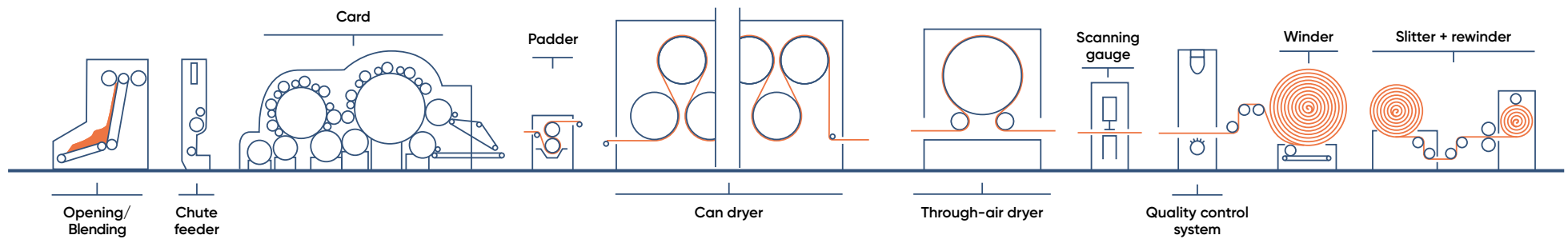

Wadding

50 – 2,500 gsm

- Wadding for the furniture industry
- Wadding for the garment industry
- Wadding for automotive
- Air filters
- Scouring pads

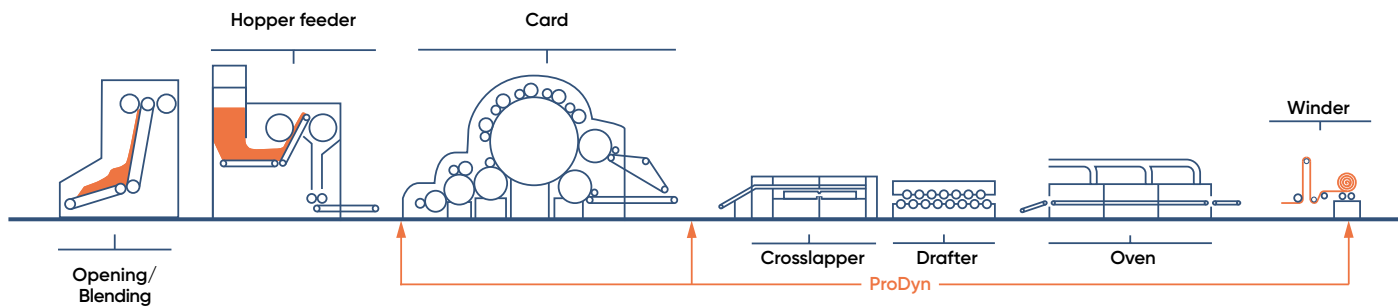



Resinfelt, automotive

400 – 2,000 gsm

- Automotive resin felt
- Automotive insulation
- Home appliance insulation

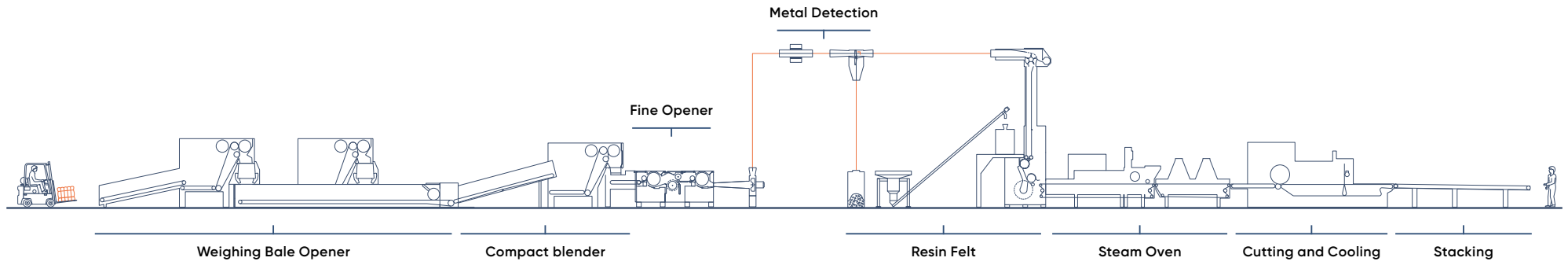

Wetlaid

New high-tech fibers and the sustainability attributes of natural fibers create new niche markets for wetlaid nonwovens. The applications range from tea bags, coffee pads and filter materials to wallpapers, flushable wipes, glass fiber mats, protective hygiene wear, and speciality papers.

Moreover, the ANDRITZ wetlaid technology targets the rising demand for eco-friendly nonwovens. Combining wetlaid and hydroentanglement enables you to produce fully biodegradable nonwovens without chemical additives or thermal bonding.



Wipes, composites

40 – 100 gsm

- Flushable wipes
- Industrial wipes
- Sustainable wipes
- Composites with additional layers

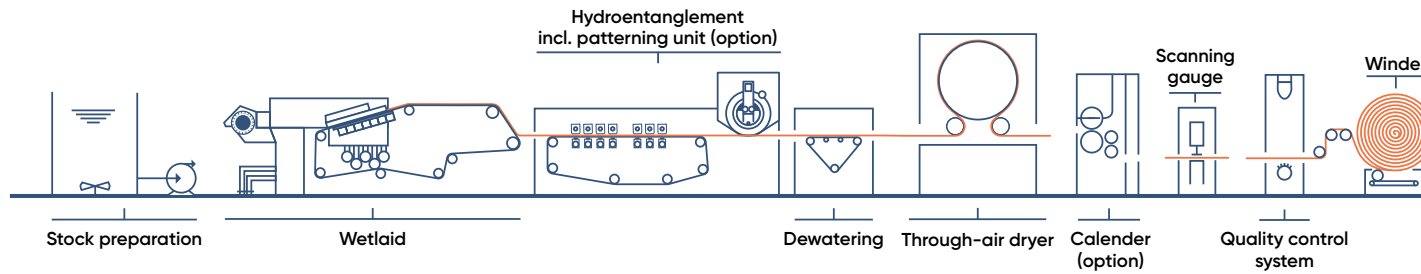

Carded-pulp wipes

40 – 100 gsm

- Baby wipes
- Disinfection wipes
- Sustainable wipes

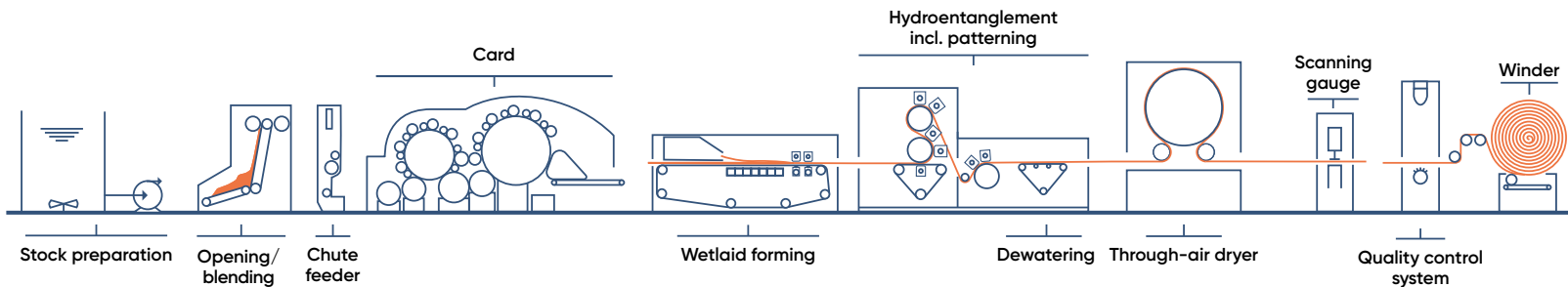



Wipes

40 – 100 gsm

- Flushable wipes
- Carded-pulp wipes
- Baby wipes
- Disinfection wipes
- Sustainable wipes

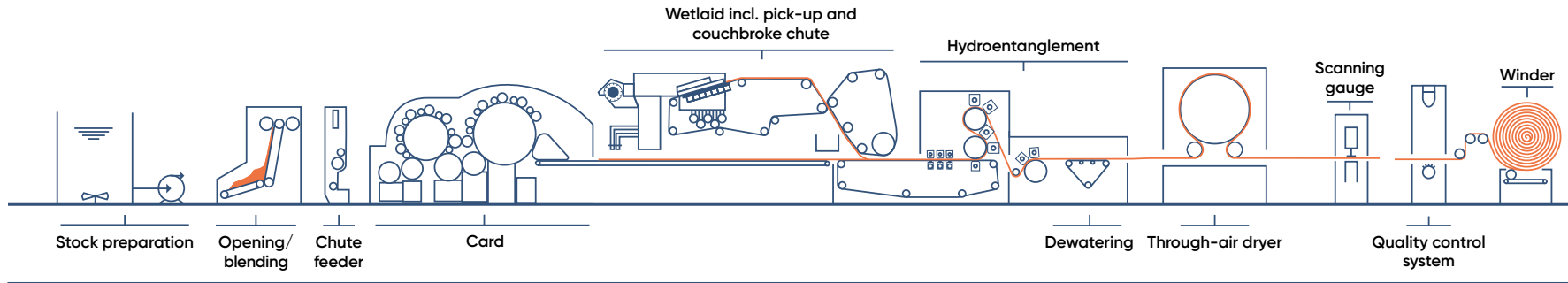

Glass fibers, carbon

20 – 240 gsm

- Construction
- Flooring
- Aircraft
- Railway
- Boat building
- Automotive

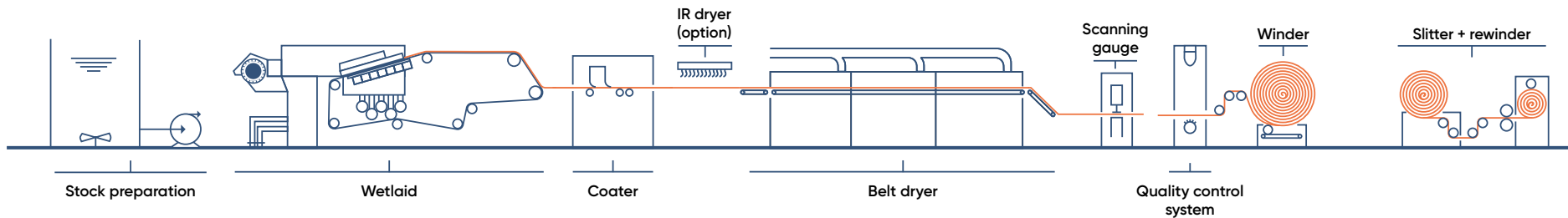



Automotive filter, wall coverings

60 – 400 gsm

- Filters
- Wall covering

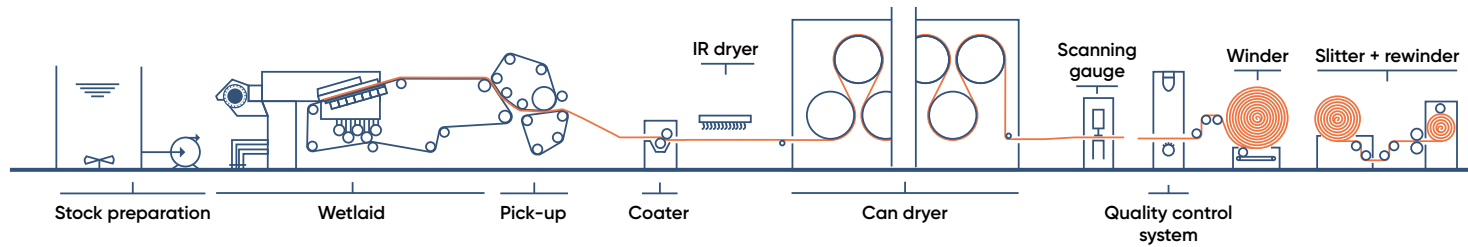

Coffee pads, tea bags

12 – 45 gsm

- Tea bags
- Coffee pads

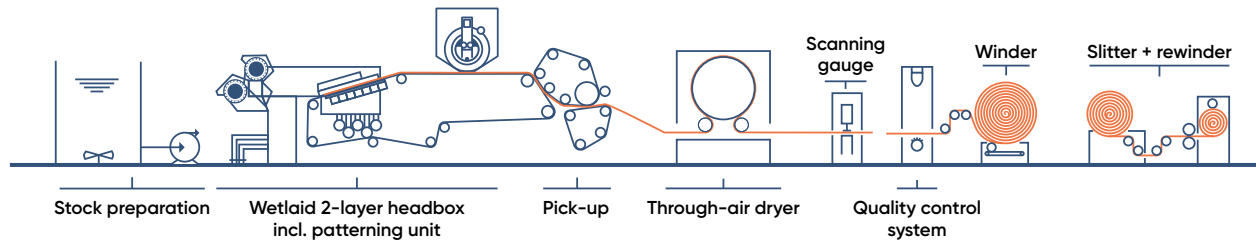

Spunlaid

From bonding to finishing: Besides our well-known calendering technologies, you can entrust your complete processes to us, including calenders, spunjet technologies, finishing solutions, and dryers. All technologies are precisely tailored to your needs. From bonding to finishing, you benefit from the highest capability, reproducibility, reliability, and efficiency. Build your spunlaid line with our innovative technologies.

Although the development of spunlaid technologies has been most visibly focused on the absorbent hygiene products and medical markets in the past decade, use of this type of nonwoven in durable applications such as filtration, geotextiles or building is also of great importance.



Hygiene, medical

8 – 80 gsm

- Health care
- Coverstock for baby diapers, adult incontinence, and femcare

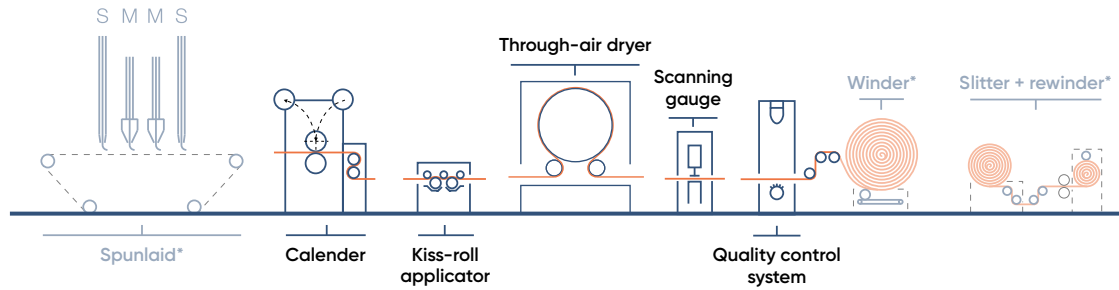

Hygiene, medical, technical

20 – 80 gsm

- Hygiene
- Medical
- Adult incontinence
- Car protection

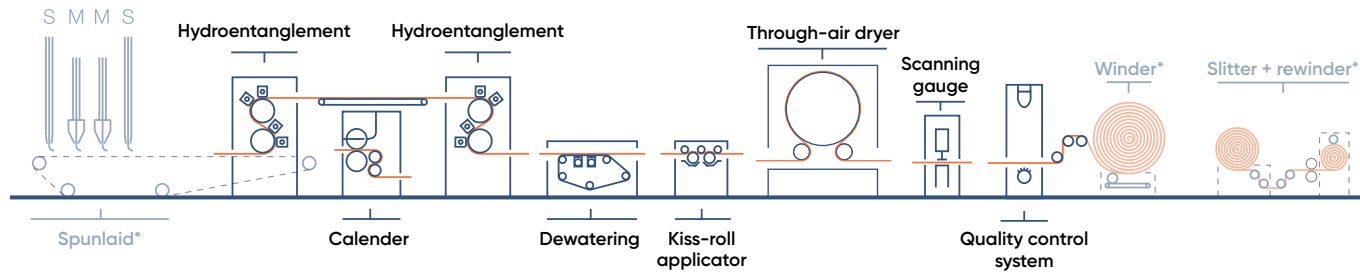



Roofing, geotextiles

90 – 1,600 gsm

- Reinforcement and stabilization
- Roofing
- Civil engineering
- Technical felts

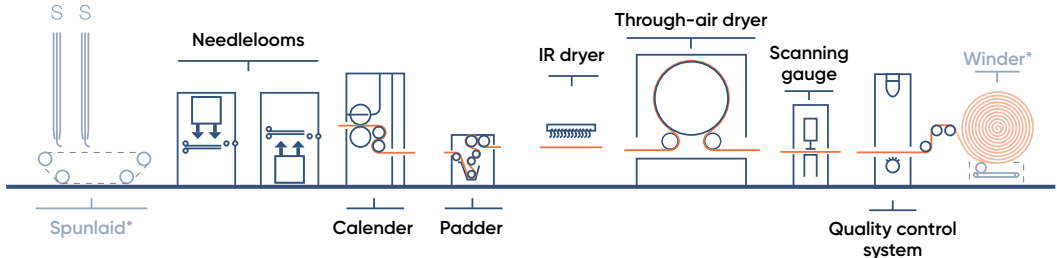

Artificial leather, air gas filtration

100 – 800 gsm

- Artificial leather
- Air gas filtration
- Technical wipes

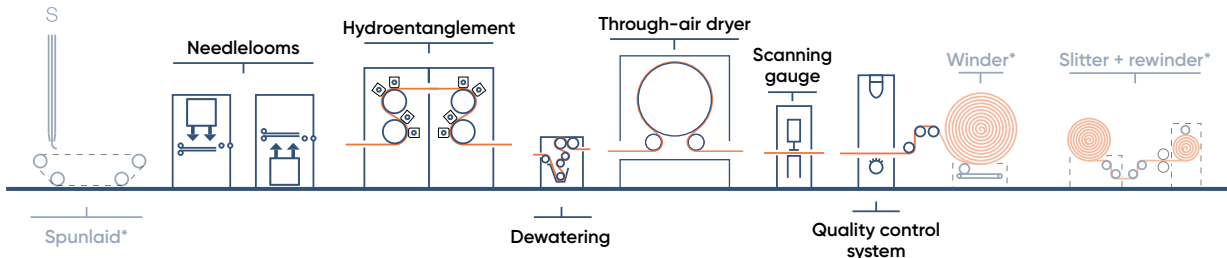

*Technology provided by cooperation partners

Finishing offline

Adding value to nonwovens: In finishing applications, nonwovens acquire improved product properties, manifold functionalities, and a significant added value. The properties that can be achieved include hydrophilic, permanently hydrophilic, anti-static, alcohol repellent, flame resistant, high softness, strength and many more finishes.



Chemical finishing

- Medical (fluorocarbon) 25 – 50 gsm
- Binder 100 – 400 gsm

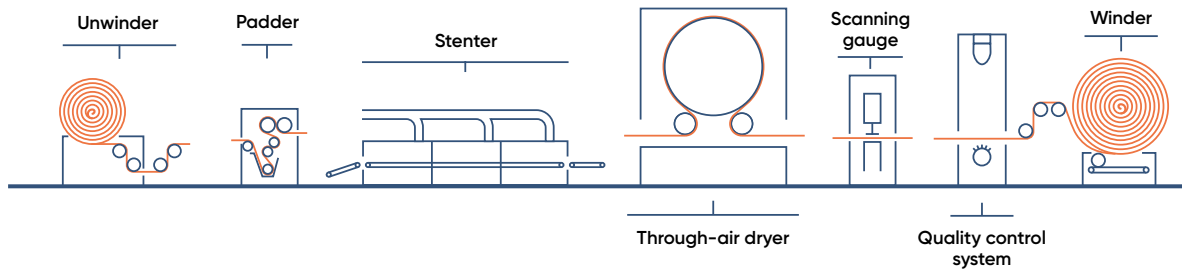

Hydrofinishing

- Splittable fibers 50 – 400 gsm
- Hot gas filtration 200 – 400 gsm
- Spunbond softening 18 – 25 gsm
- Durable wipes 150 – 200 gsm

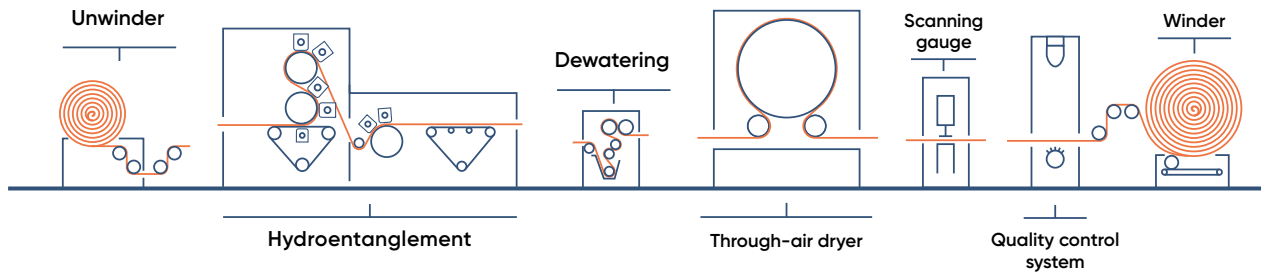



Laminating

- Roofing
- Composites

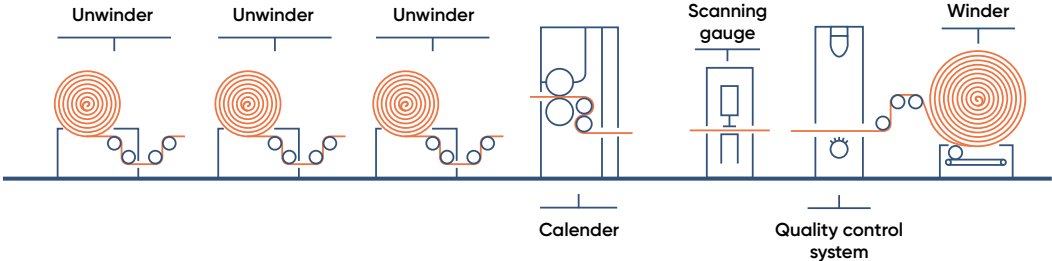

Converting

Product innovations: When it comes to nonwoven products for femcare, baby care, and adult incontinence needs, food pads, surgical drapes and lamination materials, you need an experienced technology partner at your side. One who knows where your production line can be enhanced to give products innovative features. We are also a competent partner to guide you if you are a newcomer to the business.

ANDRITZ offers you decades of experience in converting machinery with a strong global service network. You can expect tailor-made machinery and engineering that allow you to generate innovations in your market. Together with our production lines' famous reliability and productivity, you convert ideas into profitable products.



Baby diapers

- T-shape
- Elastic ears

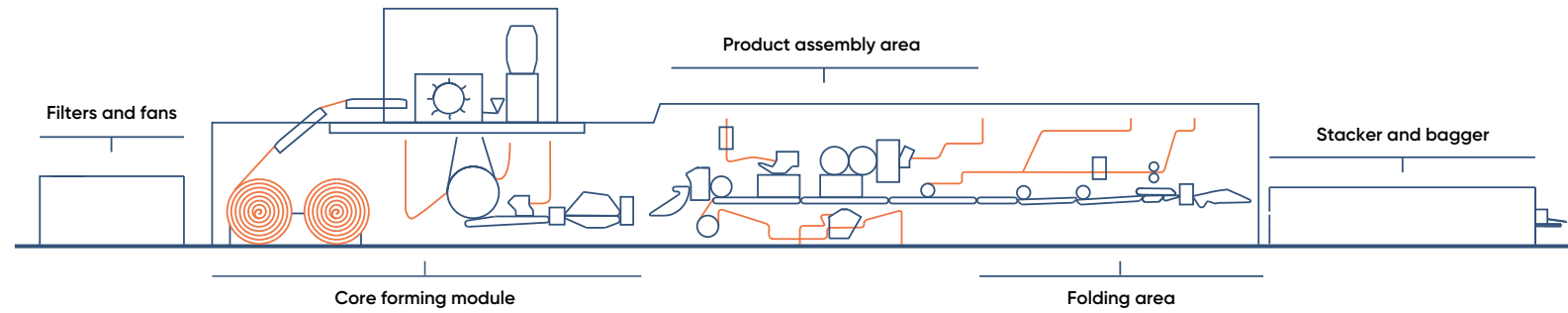

Baby pants

- Cross-direction waist elastics

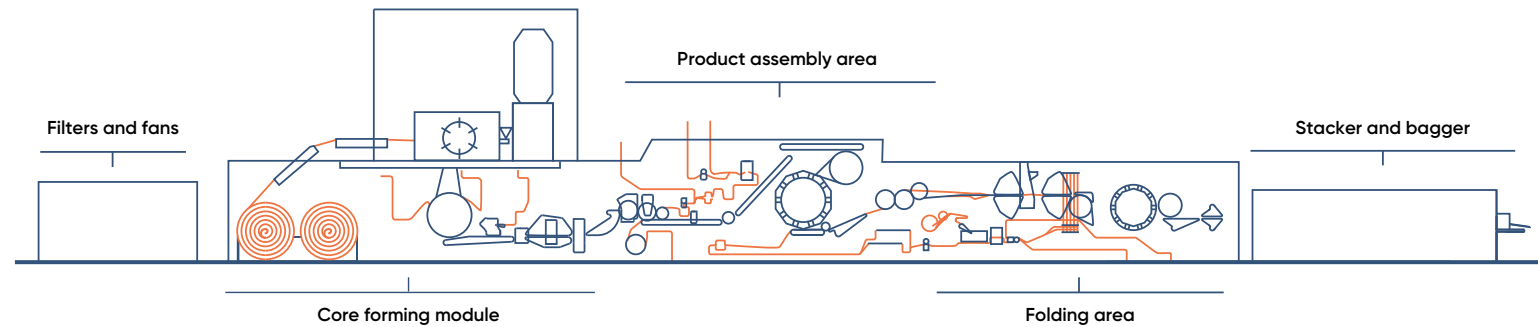



Sanitary napkins

- Fluff / airlaid / high density core
- Trifolded / straight

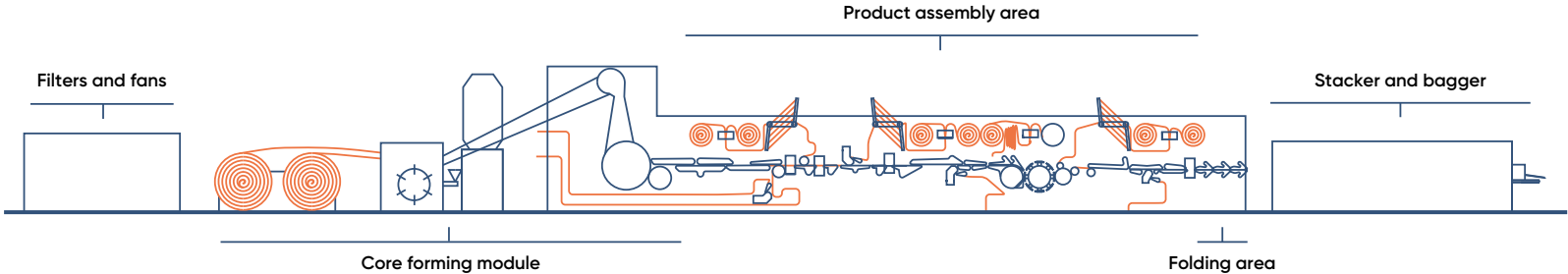

Panty shields

- Fluff / airlaid
- Trifolded / straight

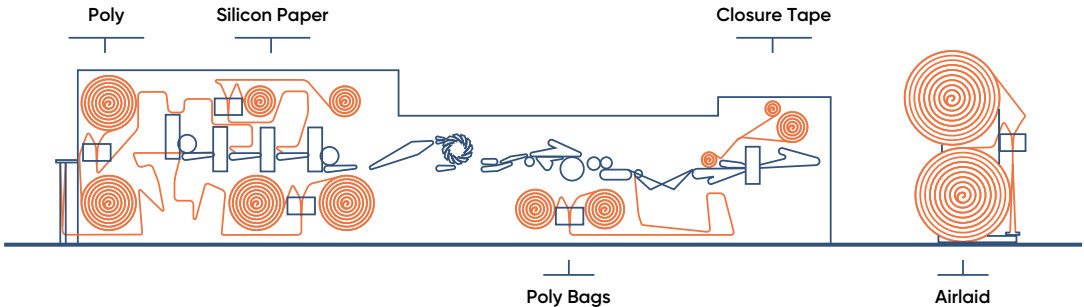



Adult diapers

- Hourglass / side panel
- Shaped pad

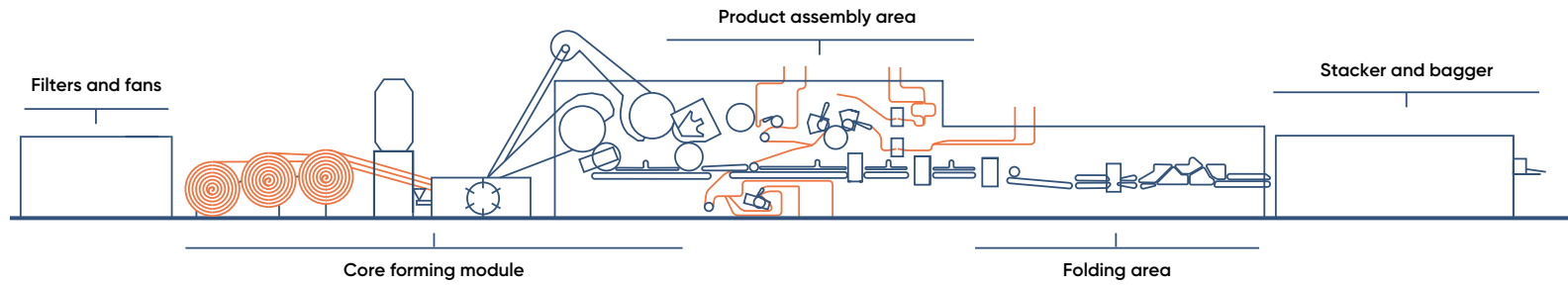

Adult pants

- Cross-direction waist elastics
- Light into female underwear / universal pants

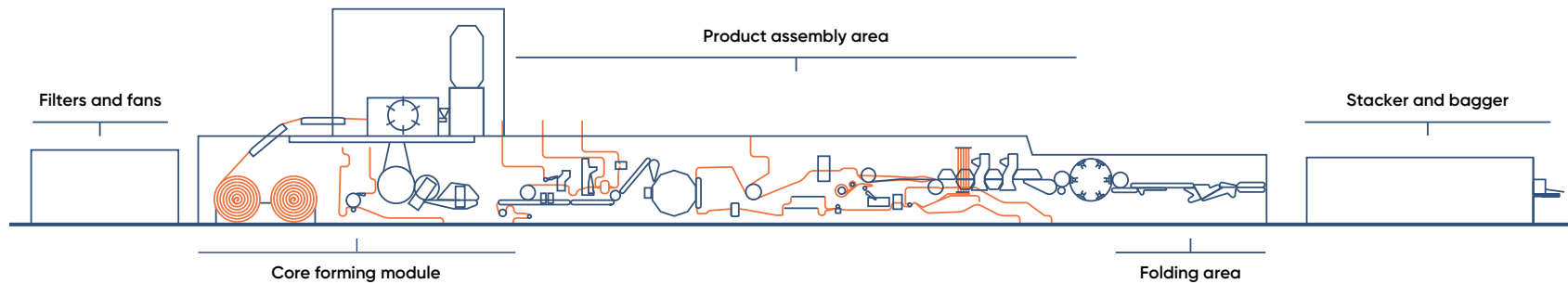



Light inco

- Foam / elasticated products
- Folded / straight
- Male products

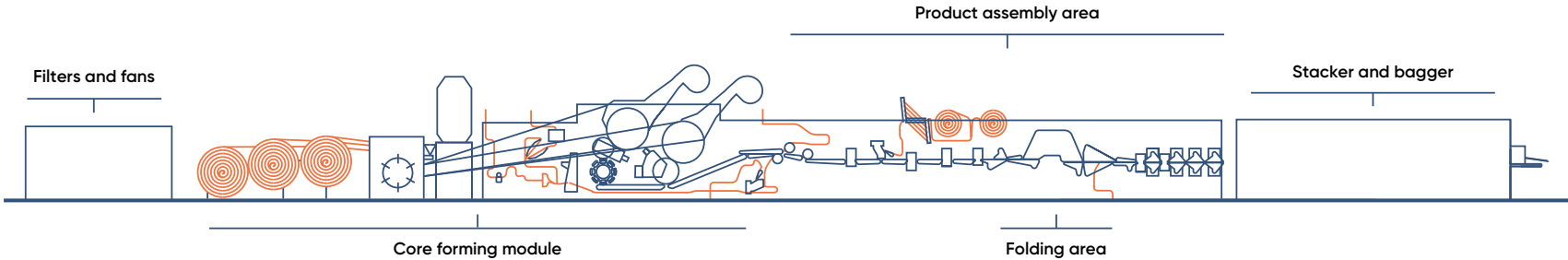

Underpads

- Pet pads
- Hospital sheets
- Baby changing mats
- Wide range of core fluff densities

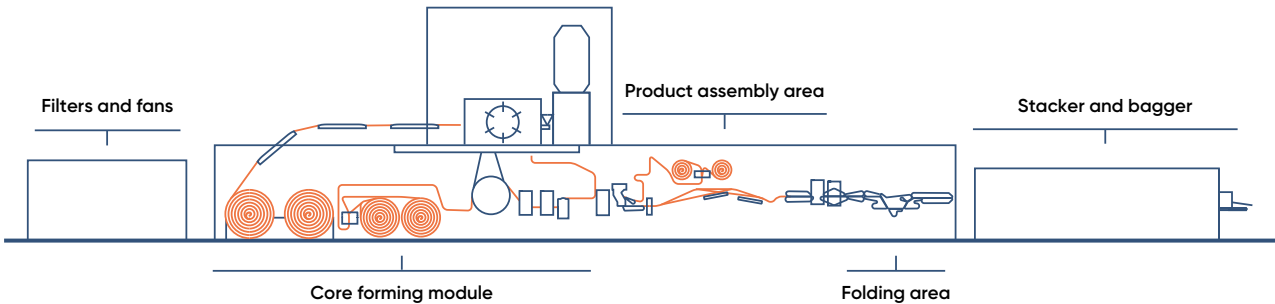



Food pads

- Airlaid / fluff core
- Sealed edge / open edge

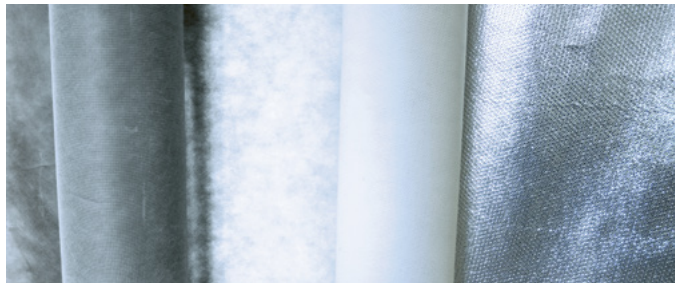
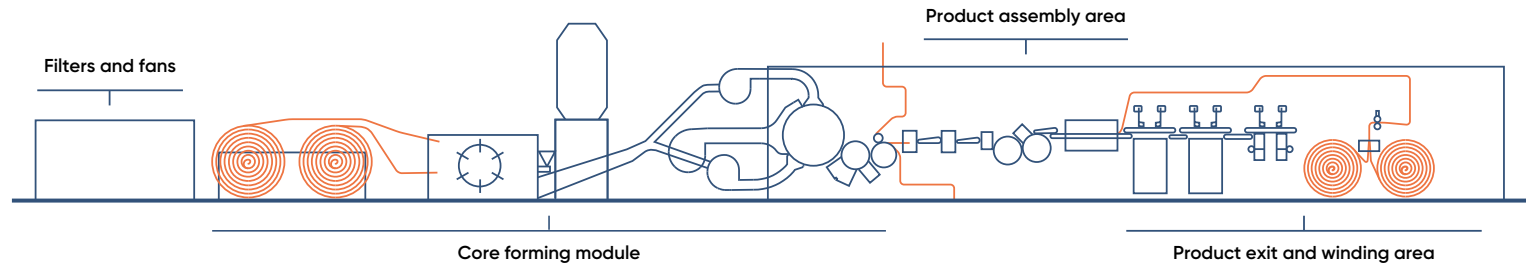

Laminating

- Buildtech
- Mobiltech
- Med-hygienetech
- Clothtech

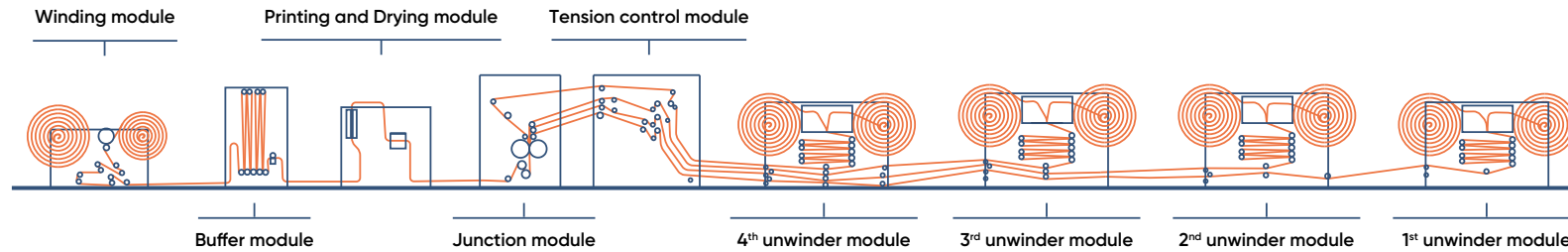



Gloves, head rests

- One-layer / two-layer solutions
- Wet / dry

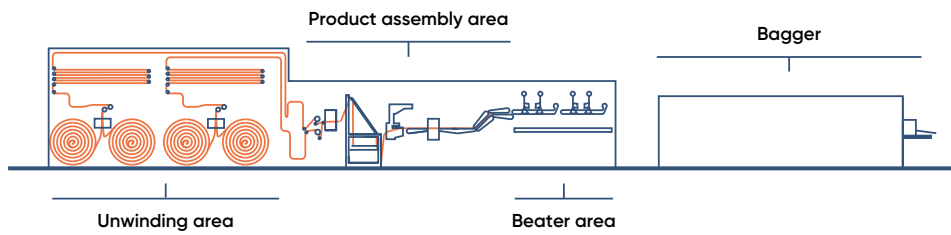

Recycling

Recycle textiles into success: ANDRITZ is the right partner when it comes to state-of-the-art recycling lines for post-consumer and industrial waste to produce fibers for re-spinning and/or nonwoven end-uses. These recycled fibers can also be used in the nonwovens industry for various applications such as automotive, insulation, mattresses, and furniture felts.

In addition, customer and end-user awareness, and regulations are pushing apparel brands to recycle their waste in their own products. ANDRITZ supports you in growing your business opportunities and create reliable and sustainable recycling processes for years to come.



Industrial soft waste
200 – 1,000 kg/hr

- Spinning
- Hygiene
- Nonwovens

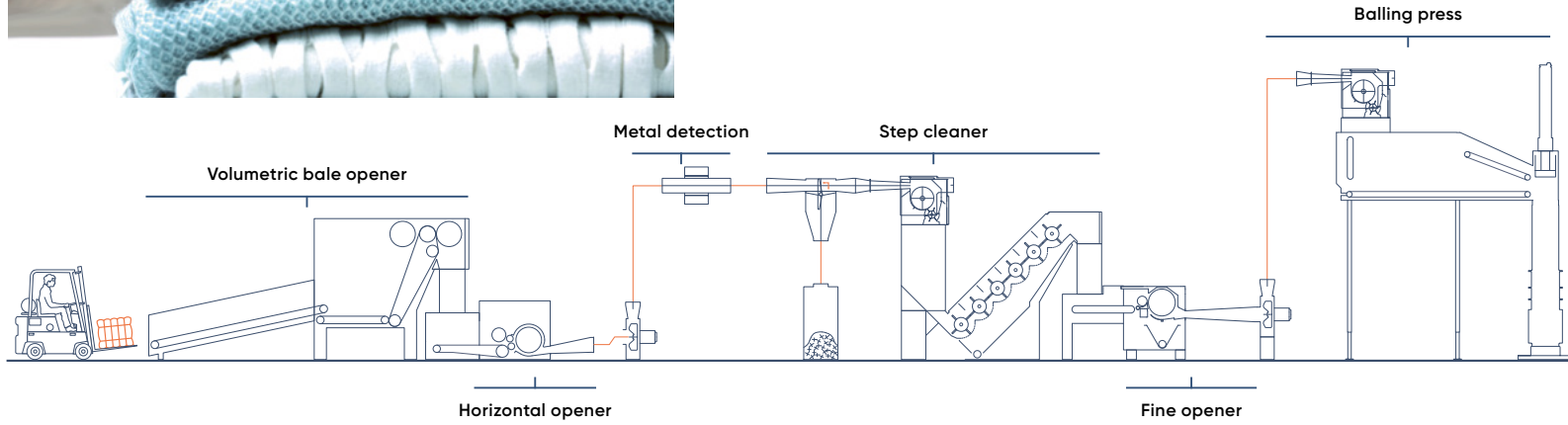

Industrial waste recycling
300 – 3,000 kg/hr

- Nonwoven quality
- Spinning quality

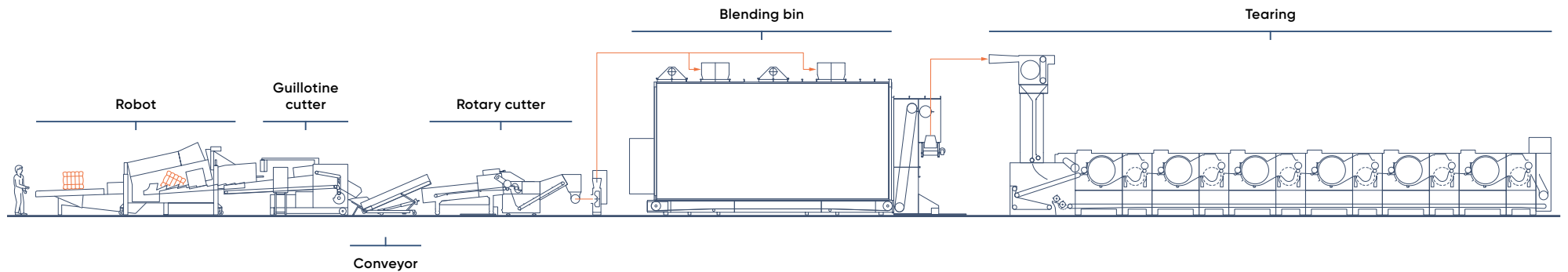



Pre- and post-consumer waste recycling

300 – 3,000 kg/hr

- Nonwoven quality
- Spinning quality

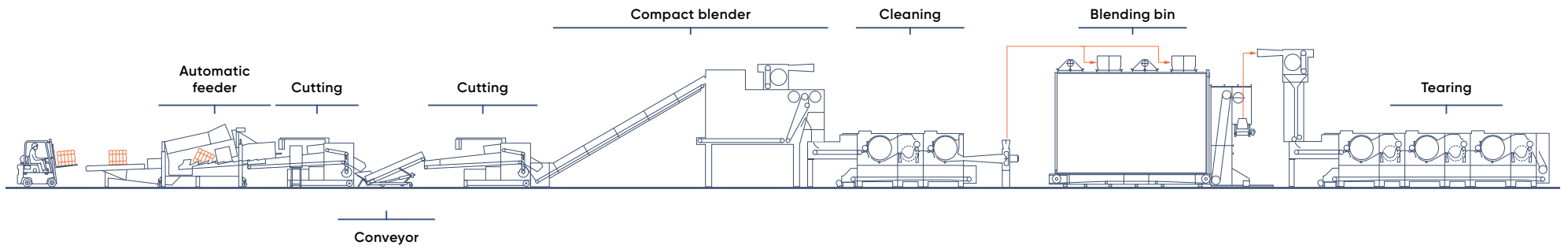

Metris

Forsee digitally with ANDRITZ Digital Solutions: Digitization in the nonwovens industry is far from a distant dream, it is now a reality. Customers can bring its production to a new level with ANDRITZ digital technologies combined under the Metris technology brand. This is making a real difference in improved production line performance.

Foresee digitally with Metris

Industrial Internet of Things (IoT) Industry 4.0, digitalization - current buzzwords that industries use when seeking to improve their performance and equip themselves for the future of industry.



ANDRITZ DIGITAL SOLUTIONS

As a technology leader with extensive and long-term experience in supplying industrial measurement, control, and optimization solutions for various industries, ANDRITZ is combining process and equipment expertise with the latest enhancements in the digital era. The result of this powerful combination is Metris: a portfolio of ANDRITZ Digital Solutions.

METRIS OPP

One of the flagship capabilities of the Metris assortment is its ability to optimize industrial processes with Metris OPP. It has been developed over the past decade within the pulp and paper sector and has recently been introduced to the nonwovens industry. It combines powerful analytical and data mining software with the knowledge of the world's top process experts to deliver a smart service initiative for customers.





Benefits

A CONSTANTLY GROWING PORTFOLIO

The depth and effectiveness of the Metris portfolio continues to improve thanks to ongoing R&D, collaboration with key customers and institutions, and venture activities. Portfolio options all rely on the three strategic focus areas of the Metris brand: Industrial IoT technologies, Smart Service concepts, and Venture activities. The main technological advancements integrated into individual Metris products are derived from big data analytics, smart sensor technologies, and augmented reality solutions. The Metris UX platform providing full support throughout the entire lifecycle of a plant is the most recent of our IoT developments. With Metris solutions, customers foresee digitally due to the continuously improved portfolio and its performance – and to ANDRITZ providing tailored and fully integrated digital solutions from a single source.

Metris – ANDRITZ Digital Solutions

- IIoT solutions across business segments
- Combined know-how from ten years' experience with Metris OPP
- Using the latest smart sensor technologies
- Big data analysis with tried-and-tested models for deviation analysis
- Providing information locally with augmented reality
- Extensive solution and process engineering knowledge
- Cyber security solution to safeguard data on the network



GERMANY

ANDRITZ Küsters GmbH
Krefeld, Germany
p: +49 2151 34 0
kuesters@andritz.com

FRANCE

ANDRITZ Asselin-Thibeau SAS
Elbeuf, France
p: +33 2 32 96 42 42
asselin-thibeau@andritz.com

ANDRITZ Laroche SAS
Cours, France
P: +33 4 74 89 84 85
laroche@andritz.com

ANDRITZ Perfojet SAS
Montbonnot, France
p: +33 4 76 52 23 11
perfojet@andritz.com

ITALY

ANDRITZ Diatec Srl
Colleciovino, Italy
p: +39 085 82060-1
diatec@andritz.com

CHINA

ANDRITZ (China) Ltd.
Wuxi branch office
Wuxi, P.R. China
p: +86 510 8536 1269
nonwoven-china@andritz.com

INDIA

ANDRITZ Technologies Pvt. Ltd.
Chennai, India
p: +91 44 4293 9393
nonwovenservice.india@andritz.com

USA

ANDRITZ Inc.
Spartanburg, USA
p: +1 864 587 4848
nonwoven-americas@andritz.com

[ANDRITZ.COM/NONWOVEN](https://www.andritz.com/nonwoven)

JOIN US ON SOCIAL MEDIA



All data, information, statements, photographs and graphic illustrations in this leaflet are without any obligation and raise no liabilities to or form part of any sales contracts of ANDRITZ AG or any affiliates for equipment and/or systems referred to herein. Picture page 7 (top) by courtesy of Manifattura Fontana s.p.a. – Sioen Group. © ANDRITZ AG 2022. All rights reserved. No part of this copyrighted work may be reproduced, modified or distributed in any form or by any means, or stored in any database or retrieval system, without the prior written permission of ANDRITZ AG or its affiliates. Any such unauthorized use for any purpose is a violation of the relevant copyright laws. Clothing picture on page 4 by courtesy of Mogul company. ANDRITZ AG, Stattegger Strasse 18, 8045 Graz, Austria. KNW.lp.eng.03.2022

